

SMCarbon[®] 26 CF40-12K

Generic Information

Sheet moulding compound based on vinyl ester resin and reinforced with carbon fibres designed for compression moulding technology. These material with a weight reduced potential and a high design freedom enter different areas for structural application where high mechanical properties are requested.

Code Description

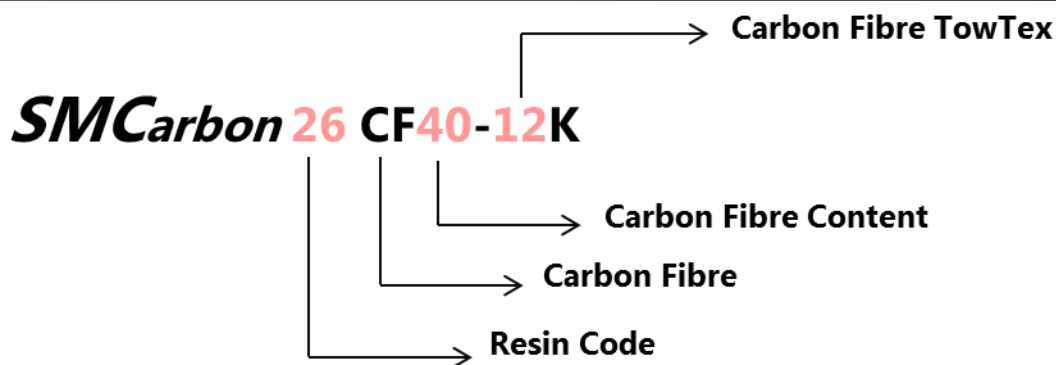

Packaging: roll
 Material width: 500 mm
 Shelf life at -18°C: 6 months
 Shelf life at RT 23°C: 8 weeks

Fibre length: 25 mm
 Fibre: 12K
 Nominal fibre content ^{w/w}: 40 %
 Areal weight: 1500 g/m²
 Typical cure temperature: 125-140 °C
 Typical moulding pressure: 80-120 bar
 Typical cure time: 35 sec/mm

Storage and Handling

Store the product in its original sealed packaging at 23°C. Leave product to reach room temperature before unrolling, to prevent condensation. The usual precautions when handling uncured synthetic resins and fine fibrous materials should be observed, and a Safety Data Sheet is available for this product. The use of clean disposable inert gloves provides protection for the operator and avoids contamination of material and components.

Mechanical Properties on cured material

Properties were determined on compression-moulded specimens according DIN EN 14598

Properties	Method	Unit	Value
Density	ISO 1183 A	g/cm ³	1.46
Shrinkage	ISO 2577	%	-0.09
Tensile Modulus	ISO 527-4	N/mm ²	19700
Tensile Strength	ISO 527-4	N/mm ²	52
Flexural Modulus	ISO 14125	N/mm ²	18400
Flexural Strength	ISO 14125	N/mm ²	196
Impact Strength	ISO 179	KJ/m ²	23
Heat Distortion Temperature	ISO 75-2°	°C	>200
Glass Transition Temperature	ISO 11357-2	°C	145

Additional Info

Disclaimer: The information on this product data sheet is based on our most up-to-date knowledge. However, it is the user's responsibility to determine the suitability of a product for their application. Information and recommendations contained in this document are given in good faith without warranty or guarantee, and it is the user that is responsible for the compliance with all legal requirements. The user is urged to carry out tests for themselves to determine the suitability of any product for their proposed applications. All the trademarks, trade names, logos and other indications of origin mentioned on the product data sheet are property rights of Polynt Composites Germany GmbH.

Contacts

Polynt Composites Germany GmbH

Kieselstrasse 2

D-56357 Miehlen

Tel. +49 (0)6772 93 21 0

Fax. +49 (0)6772 93 68 88

Email: carboninfo@polynt.com

Jurisdiktion Koblenz; HRB 20782

www.polynt.com

